

tala[®]

EU FITTING INSTRUCTIONS

*Oak & Walnut
Knuckle Pendant*

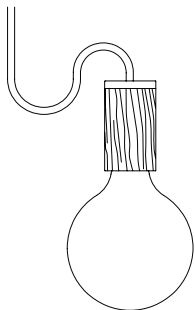

BEFORE STARTING

We advise the fitting of our ceiling rose and pendant to be performed by a qualified electrician. Please read through these instructions before commencing work, and keep them for future reference. Please take extreme care when carrying out these instructions.

Important! This light fitting must be connected to the supply earth. If your lighting circuit does not have an earth, ask a qualified electrician to provide an earth facility. Light fittings should be connected to a 5 amp fused circuit. This light fitting is suitable for indoor use only. This fitting operates on 240V mains voltage and our recommended dimmer is Lutron - Diva DVELV-300P-XX (XX denotes faceplate colour).

Warning! Always switch off electricity supply at the mains during installation and maintenance. We recommend that the fuse is withdrawn or the circuit breaker is switched off whilst work is in progress. Do not just turn off at the wall switch. All fittings must be installed in accordance with current Building Regulations and IEE Wiring Regulations.

PROVIDED COMPONENTS

(A) x1 Rose and Cable

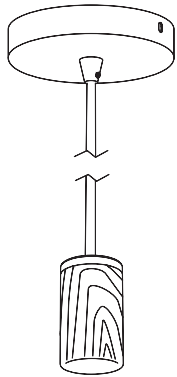

(B) x1 Ceiling Bracket

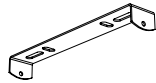

(C) x2 Bolts (10mm M4)



(D) x1 Gub/Set Screw

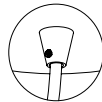

RECOMMENDED EQUIPMENT

- Small electrical screwdriver
- Insulation tape
- Cross head screwdriver
- x2 Wall Screws
- Wire strippers
- x2 Wall Plugs

Further equipment may be required for making holes in your ceiling.

STEP 1

Attach component (B) to your ceiling using screws and plug. Always choose screws and plugs that are appropriate for the material.

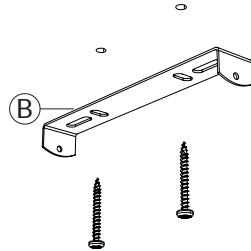

STEP 2

Adjust the length to your desired length. Using a flat head screw driver, tighten 'grub/set screw' (D). This will secure the cable in place.

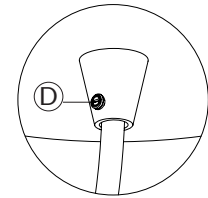

STEP 3

First identify your household wiring using IEE Wiring regulations. Attach the pendant wiring to your household supply as seen below. Use an appropriate junction box.

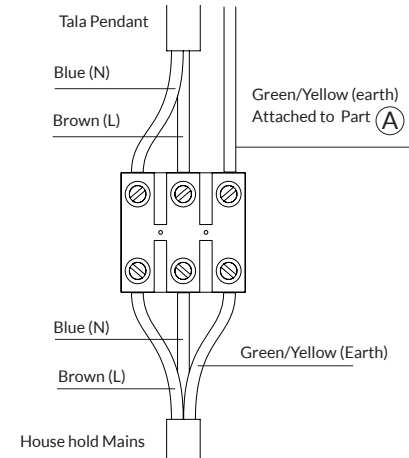

STEP 4

Fasten part (A) to part (B) using the bolts provided.

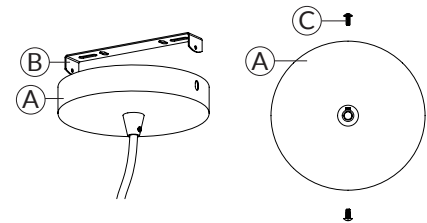

CARE AND CLEANING

We recommend cleaning with a soft dry cloth. Do not use abrasive materials as these will damage the finish.

WARRANTY AND AFTER-CARE

This product has a one-year warranty. Within this time we will replace any fixtures that have functional defects. Please report any faults by emailing customerservice@taled.com.



Tala, 25B Vyner Street,
London, E2 9DG
+44 (0) 20 3026 3246