



USER INSTRUCTIONS

COPENHAGEN PENDANT SC6

BY SPACE COPENHAGEN
2014

Congratulations on choosing this original Copenhagen Pendant SC6 lamp, designed in 2014 by Space Copenhagen. We hope you will enjoy using this product and follow these instructions to ensure correct installation. If you have any questions or comments, please do not hesitate to contact us by mail on:

info@andtradition.com

CONTENTS

- A - Shade
- B - 4 meter fabric cord fitted with ceiling loop and connector block
- C - Canopy with metal ceiling bracket

Please read these instructions carefully and retain them for future reference to ensure that the lamp is used correctly. For your own safety, please study each step of this instruction manual first. &tradition is not responsible for any faults or damages caused by not following these instructions correctly. Do not modify this lamp in any way.

TOOLS NEEDED

- Small flat-head screwdriver for wiring
- Cable cutters
- Cable stripper
- Bulb type: G9 max 40 Watt

SAFETY PRECAUTIONS

- Dispose of the bag from packaging and do not allow children to play with it.
- Keep product well out of children's reach.
- The lamp is only intended for interior use.
- Do not attempt installation of product if you are not competent to do so yourself.
- Consult a professionally qualified electrician if in any doubt.
- Disconnect the electricity supply at the fuse box, before commencing work.

CLEANING INSTRUCTIONS

- Wipe surface of the lamp shade with a soft dry cloth.
- Do not use any abrasive cleaning tools such as steel wool, scouring sponges or stiff brushes.
- Never use strong cleaning agents such as white spirit, turpentine, household glass cleaner or cellulose thinners.

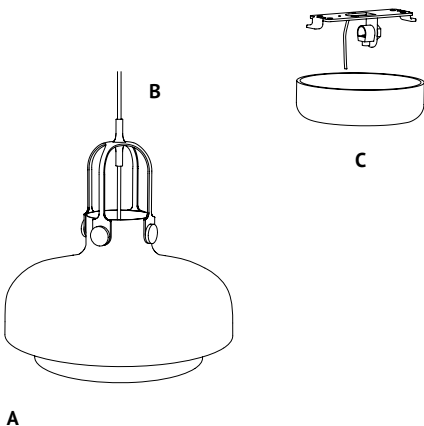

A

B

C

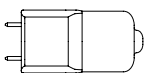

Maximum 40 W. G9 bulb.

Not included

&tradition®

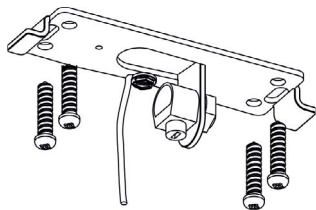

STEP 1

Ensure power supply is turned off and remove any existing lamp fitting. Locate the supply cable and ensure it is ready to be fitted to the connector block.

Mount the metal bracket securely in the ceiling with screws and wall plugs, appropriate for the ceiling of installation.

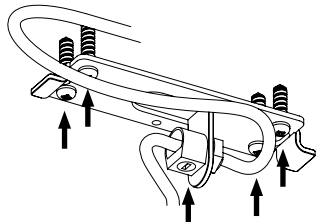

STEP 2

To determine the right suspension height for the lamp, pass the electrical cord through the strain relief of the metal bracket. When you have the desired suspension height of the lamp, tighten the plastic screw of the strain relief.

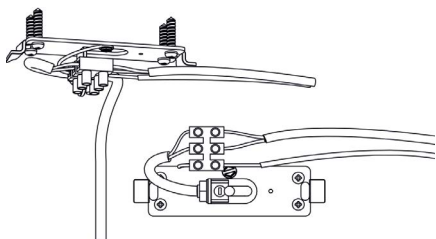

STEP 3

Connecting the wires:

Cut off the excess cord using a cable cutter so that minimum of 80 mm cord is left to reconnect to the cable connector. Peel back the outer cable using a cable stripper to expose 30 mm of the blue and brown inner cables. Strip the inner cable to expose 5 mm of wire. Connect the blue supply wire to the blue fixture wire. Connect the brown supply wire to the brown fixture wire. Connect the green supply wire to the green fixture wire.

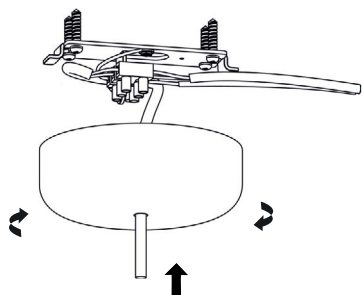

STEP 4

Install the plastic canopy onto the metal bracket.

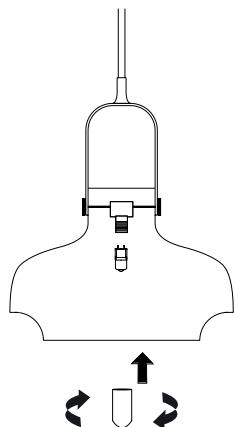

STEP 5

Bulb installation:

Unscrew the small glass diffuser installed in the bulb socket.

Insert the G9 bulb in the socket (when installing the bulb - make sure the bulb metal pins are not loose inside the bulb socket. Please also avoid touching the bulb with your fingers - use a dry cloth or a paper tissue).

Mount the glass diffuser back onto the bulb socket.

220-240V - 50 Hz



tradition®



USER INSTRUCTIONS

COPENHAGEN PENDANT SC6

BY SPACE COPENHAGEN
2014

Congratulations on choosing this original Copenhagen Pendant SC6 lamp, designed in 2014 by Space Copenhagen. We hope you will enjoy using this product and follow these instructions to ensure correct installation. If you have any questions or comments, please do not hesitate to contact us by mail on:

info@andtradition.com

CONTENTS

- A - Shade
- B - 4 meter fabric cord fitted with ceiling loop and connector block
- C - Canopy with metal ceiling bracket

Please read these instructions carefully and retain them for future reference to ensure that the lamp is used correctly. For your own safety, please study each step of this instruction manual first. &tradition is not responsible for any faults or damages caused by not following these instructions correctly. Do not modify this lamp in any way.

TOOLS NEEDED

- Small flat-head screwdriver for wiring
- Cable cutters
- Cable stripper
- Bulb type: G9 max 40 Watt

SAFETY PRECAUTIONS

- Dispose of the bag from packaging and do not allow children to play with it.
- Keep product well out of children's reach.
- The lamp is only intended for interior use.
- Do not attempt installation of product if you are not competent to do so yourself.
- Consult a professionally qualified electrician if in any doubt.
- Disconnect the electricity supply at the fuse box, before commencing work.

CLEANING INSTRUCTIONS

- Wipe surface of the lamp shade with a soft dry cloth.
- Do not use any abrasive cleaning tools such as steel wool, scouring sponges or stiff brushes.
- Never use strong cleaning agents such as white spirit, turpentine, household glass cleaner or cellulose thinners.

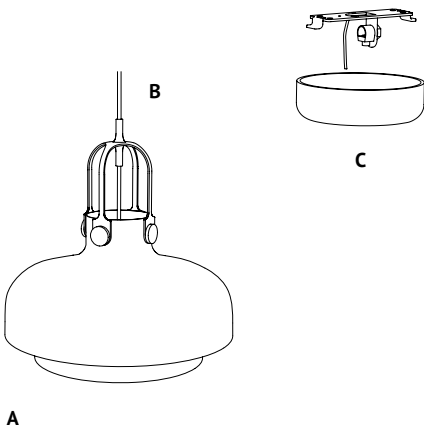

A

B

C

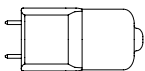

Maximum 40 W. G9 bulb.

Not included

&tradition®

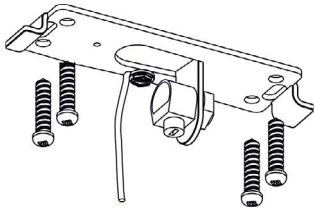

STEP 1

Ensure power supply is turned off and remove any existing lamp fitting. Locate the supply cable and ensure it is ready to be fitted to the connector block.

Mount the metal bracket securely in the ceiling with screws and wall plugs, appropriate for the ceiling of installation.

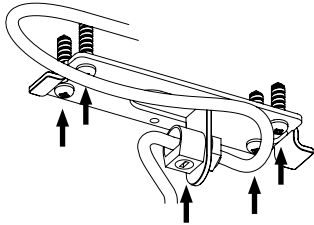

STEP 2

To determine the right suspension height for the lamp, pass the electrical cord through the strain relief of the metal bracket. When you have the desired suspension height of the lamp, tighten the plastic screw of the strain relief.

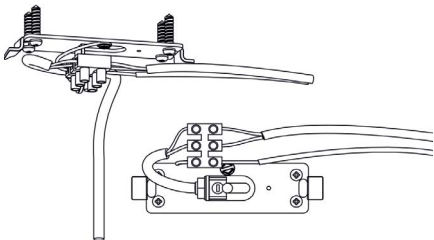

STEP 3

Connecting the wires:

Cut off the excess cord using a cable cutter so that a minimum of 80 mm cord is left to reconnect to the cable connector. Peel back the outer cable using a cable stripper to expose 30 mm of the blue and brown inner cables. Strip the inner cable to expose 5 mm of wire. Connect the blue supply wire to the blue fixture wire. Connect the brown supply wire to the brown fixture wire. Connect the green supply wire to the green fixture wire.

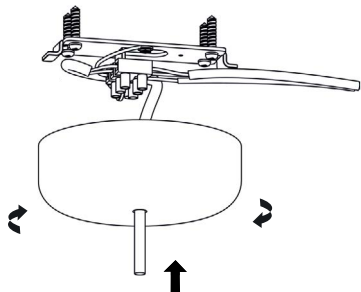

STEP 4

Install the plastic canopy onto the metal bracket.

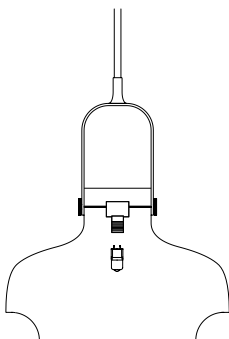

STEP 5

Install the G9 bulb.

220-240V - 50 Hz



tradition®



USER INSTRUCTIONS

COPENHAGEN PENDANT SC6

BY SPACE COPENHAGEN
2014

Congratulations on choosing this original Copenhagen Pendant SC6 lamp, designed in 2014 by Space Copenhagen. We hope you will enjoy using this product and follow these instructions to ensure correct installation. If you have any questions or comments, please do not hesitate to contact us by mail on:

info@andtradition.com

CONTENTS

- A - Opal glass shade
- B - 4 meter fabric cord fitted with ceiling loop and connector block
- C - Two-part ceiling cup

Please read these instructions carefully and retain them for future reference to ensure that the lamp is used correctly. For your own safety, please study each step of this instruction manual first. &tradition is not responsible for any faults or damages caused by not following these instructions correctly. Do not modify this lamp in any way.

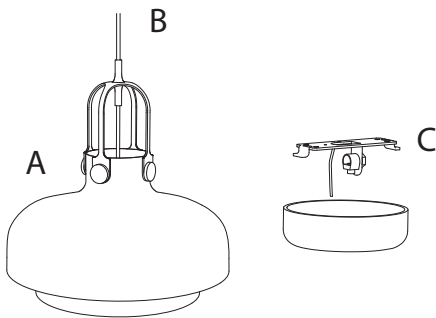

TOOLS NEEDED

- Small flat-head screwdriver for wiring
- Cable cutters
- Cable stripper
- Bulb type: G9 max 40 Watt

SAFETY PRECAUTIONS

- Dispose of the bag from packaging and do not allow children to play with it.
- Keep product well out of children's reach.
- The lamp is only intended for interior use.
- Do not attempt installation of product if you are not competent to do so yourself.
- Consult a professionally qualified electrician if in any doubt.
- Disconnect the electricity supply at the fuse box, before commencing work.

CLEANING INSTRUCTIONS

- Wipe surface of the lamp shade with a soft dry cloth.
- Do not use any abrasive cleaning tools such as steel wool, scouring sponges or stiff brushes.
- Never use strong cleaning agents such as white spirit, turpentine, household glass cleaner or cellulose thinners.

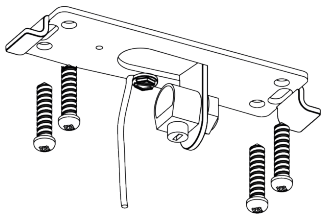

STEP 1

Ensure power supply is turned OFF and remove any existing lamp fitting. Locate the supply cable and ensure it is ready to be fitted to the connector block. Mount the metal plate securely in the ceiling with screws and appropriate wallplugs for the type of ceiling of the installation.

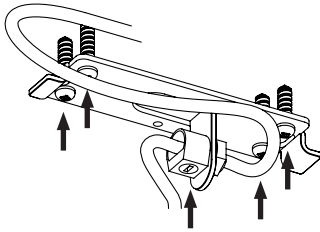

STEP 2

To determine the right hanging height for the lamp, pass the electrical cord through the strain relief of the metal plate, when the desired height of the lamp is defined, tighten the plastic screw of the strain relief.

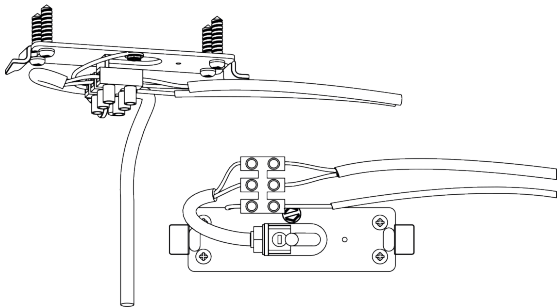

STEP 3

Connecting the wires:

Cut off the excess cord using a cable cutter so that a minimum of 80 mm cord is left to reconnect to the cable connector. Peel back the outer cable using a cable stripper to expose 30 mm of the blue and brown inner cables. Strip the inner cable to expose 5 mm of wire. Connect the blue supply wire to the blue fixture wire. Connect the brown supply wire to the brown fixture wire. Connect the green supply wire to the green fixture wire.

STEP 4

Install the plastic canopy onto the metal plate.

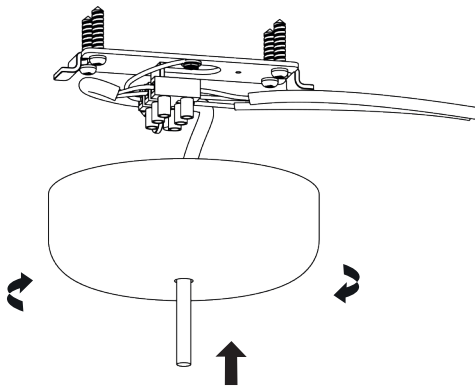

STEP 5

Bulb installation:

- Unscrew the small glass diffuser installed in the bulb socket.
- Install the G9 bulb onto the socket (when installing the bulb - make sure the bulb metal pins are not loose when inside the bulb socket. Also avoid touching the bulb with your fingers - use a dry cloth or a paper tissue).
- Screw the glass diffuser back onto the bulbsocket.

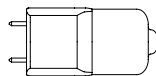
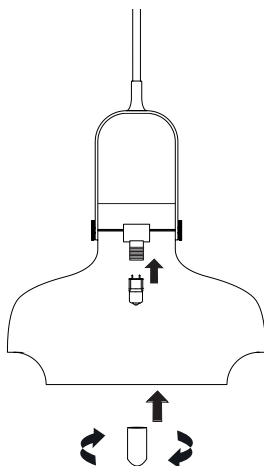

Maximum 40 W.
G9 bulb.



& tradition®