

Norma

Design by Lievore Altherr Molina, 2005

Art. 1702 1705

Chair with steel frame and covered legs. Polyurethane shell upholstered in hard leather grade 1 or hard leather grade 2 (CU). Available in two versions: with classic stitching (Art. 1702) or with decorative zipper (Art. 1705). Integrated armrests in aluminium are available on request (Art. 1702). Backrest height 86 cm.



Dimensions *

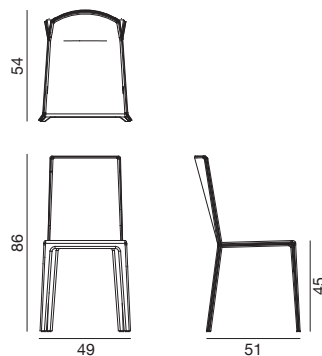

* File CAD 2D - 3D available for download at www.arper.com

Shell

Hard leather Grade 1 and Grade 2



CT



CU

arper

F +39 0422 791800

T +39 0422 7918

www.arper.com

Norma

Design by Lievore Altherr Molina, 2005



Armrests BI





Armrests BR

SHIPMENT DETAILS

Art.1702

1 pz = 1  - kg 10,7/ m³ 0,33

2 pz = 1  - kg 19,3/ m³ 0,3

1 pz = 1  - kg 10,7/ m³ 0,33

2 pz = 1  - kg 20/ m³ 0,29

TECHNICAL SPECIFICATIONS

RESISTANCE TEST

FIRE RETARDANT TEST

California TB117-2013 CT CU • BS5852 Sch. 5 Part 1 CT CU

ENVIRONMENTAL CERTIFICATIONS



arper

F +39 0422 791800

T +39 0422 7918

www.arper.com

Norma

Design by Lievore Altherr Molina, 2005

Art. 1708 1721

Chair with steel frame and legs available upholstered, chromed or powdercoated steel or veneered. Polyurethane upholstered shell with medium backrest available with upholstery in fabric, faux leather, leather or customer's material. Integrated armrests in aluminium, also upholstered, are available on request (Art. 1708). Backrest height 85 cm.



Dimensions *

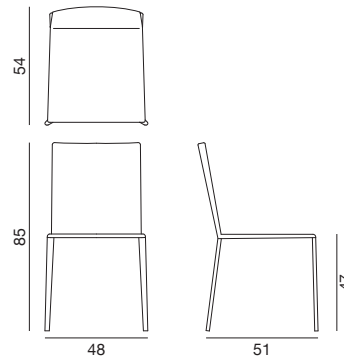

* File CAD 2D - 3D available for download at www.arper.com

Carded In

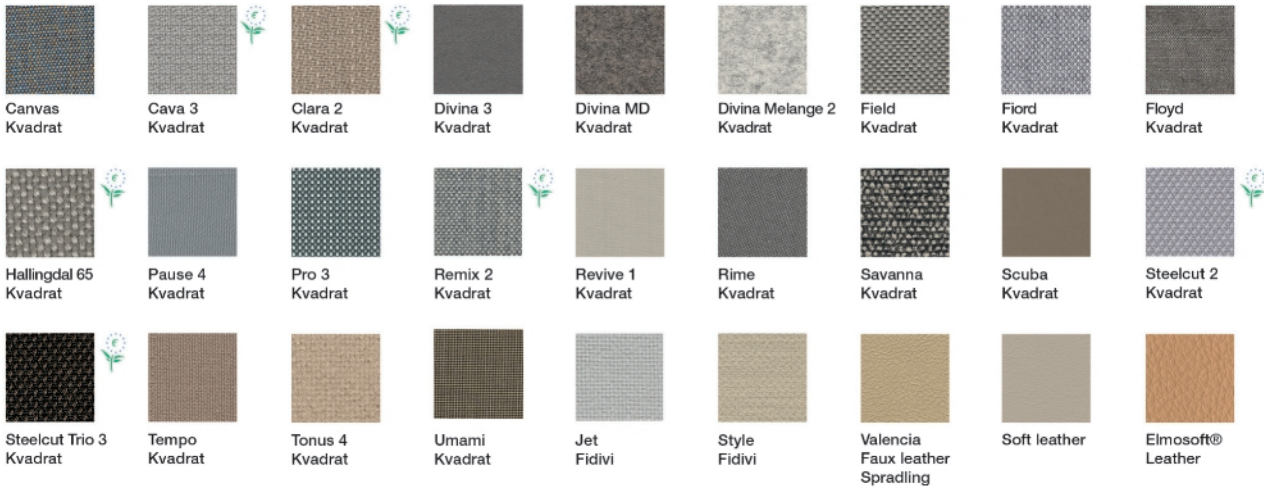

Graded In

kvadrat

camira



DESIGN
TEX



Gabriel



svensson

maharam

Serge Ferrari

Norma

Design by Lievore Altherr Molina, 2005



Armrests BI



Armrests BR

SHIPMENT DETAILS

Art.1708

1 pz = 1 - kg 10,7/ m³ 0,28

2 pz = 1 - kg 19,3/ m³ 0,4

1 pz = 1 - kg 5/ m³ 0,04

RESISTANCE TEST

TECHNICAL SPECIFICATIONS

Art.1708

COL requirement m² 1.98

H 140 cm. COM Meterage ml 1.21

FIRE RETARDANT TEST

California TB117-2013 Cava 3 Clara Canvas Divina MD Divina Melange 2 Divina 3 Soft leather Elmosoft Field Hallingdal 65 Jet Jumper 3 Pro 3 Soft leather Pause 4 Remix 2 Savanna Steelcut 2 Scuba Steelcut Trio 2 Steelcut Trio 3 Sunniva Sunniva 2 Tonus 4 Tempo Faux leather Valencia • BS5852 Sch. 5 Part 1 Cava 3 Clara Canvas Divina MD Divina Melange 2 Divina 3 Soft leather Elmosoft Hallingdal 65 Soft leather Remix 2 Savanna Steelcut 2 Steelcut Trio 2 Steelcut Trio 3 Tonus 4 Faux leather Valencia

ENVIRONMENTAL CERTIFICATIONS



arper

F +39 0422 791800

T +39 0422 7918

www.arper.com